



RPM 120 WOOD

SERIES: PAVESI TRADITIONAL BRICK OVENS



Standard Pavesi
RPM 120

JOB NAME: _____

REFERENCE INVOICE #: _____

CUSTOM FACADE: YES NO

CUSTOM FACADE DOCUMENT #: _____

• Pavesi RPM 120 is constructed in a place by a certified Forza Forni Technician.

REFRACTORY MONOBLOCK FLOOR

The Pavesi RPM 120 features the world's only refractory commercial brick oven floor in one solid block.

TRADITION & TECHNOLOGY

The Pavesi RPM 120 is designed to preserve traditional Italian hearth oven dynamics with maximum consistency for high output.

VERSATILE & RELIABLE

The Pavesi RPM 120 design exceeds at holding a wide variety of temperatures to achieve almost any pizza size and style.



Approved by
the Association
of Neapolitan
Pizzaiuoli of
America

FEATURES

The Pavesi RPM 120 is a hand-built Italian hearth-style brick oven designed and manufactured in Modena, Italy. The solid, single piece refractory floor diameter is 47 1/4", with a front-facing stone arch opening which allows access to the hearth at 23" wide by 11" tall. Wood fuel is combusted directly within the oven hearth which maximizes energy efficiency and power. The internal refractory dome and single piece floor are sealed with a refractory cement and over-insulated with high quality asbestos-free ceramic blankets to ensure maximum heat retention. The oven structure is formed by a wrapped steel sheet painted "Rosso Corso" red, and sits on top of four circular dark grey steel legs. Custom options include a single-flame powered gas burner for use as a primary oven heat source. The self-modulating gas burner monitors the oven floor temperature to adjust the BTU input for maximum efficiency and steady performance. Custom facade options can be found online at www.forzaforni.com.

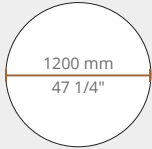
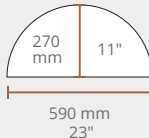
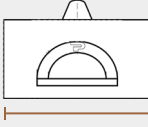
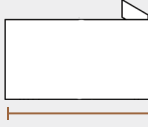
BAKING SURFACE	OVEN OPENING	EXTERNAL WIDTH	EXTERNAL DEPTH
			

OVEN PRODUCTION

12" PIZZA CAPACITY: 6 - 7 PIZZAS

RECOMMENDED BAKING TIME: 90 - 240 SECONDS (DEPENDING ON PIZZA STYLE)

RECOMMENDED OVEN FLOOR

TEMPERATURE RANGE: 600°F - 900°F (DEPENDING ON PIZZA STYLE)

DAILY PREHEAT TIME: 30 MINUTES

CUSTOM FACADE OPTIONS



TILE



STUCCO



METAL WRAP

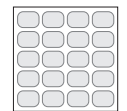

BRICK

(Please circle one. Depending on your preference, a custom facade worksheet will be sent to you)

FORZA FORNI
601 N Main St, Brewster, NY 10509
Email: info@forzaforni.com
www.forzaforni.com

844-OVEN-INC (844-683-6462)
Toll-free in USA
(Hablamos Español,
Falamos Português)

Listed to: UL 2162-ULC/ORD C2162,
ANSI Z83.11-CSA 1.8, & NSF-4 for
Commercial Wood Fired and
Gas Fired Cooking Equipment



DOC#: RPM120-0518

REVISED SPRING 2018. As products continue to improve, spec sheets may change without notice. Please call Forza Forni for the latest specification sheet and for further details.

MADE IN ITALY



RPM 120 WOOD

SERIES: PAVESI TRADITIONAL BRICK OVENS

DETAILED SPECS

WEIGHT:
2,420 LB

We make every effort to provide accurate information regarding manufacturer's reported dimension information. Please note that due to the artisan nature of the manufacturing process, from time to time, product sizing and ship weight may vary slightly.

FRONT ELEVATION

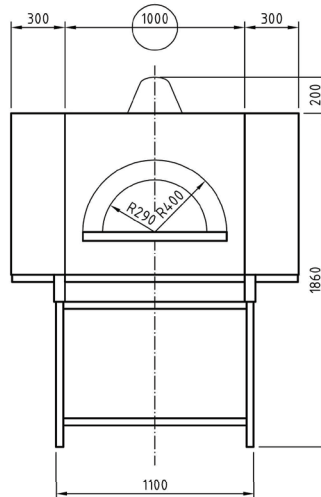

PLAN VIEW

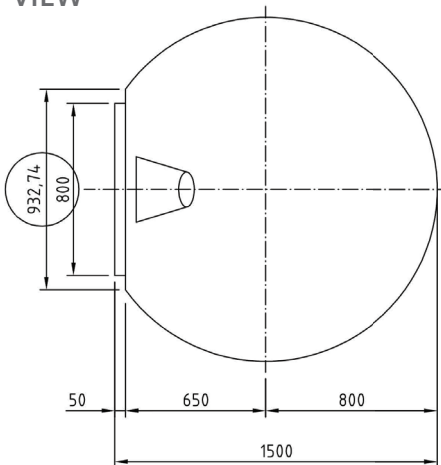

RIGHT ELEVATION

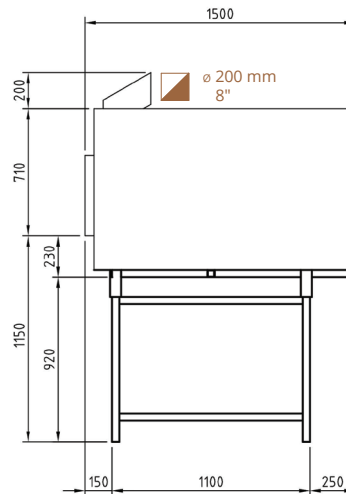

KEY



Flue Collar Exhaust Connection

All measurements listed in millimeters

CLEARANCES

Minimum clearance of the oven (built-in or standalone) to combustible materials are as follows:

Top: 14" (356 mm)
Back & Sides: 1" (25 mm)

- Non-combustible flooring must extend out at least 36" (914 mm) from oven opening and at least 30" (762 mm) to each side of the opening.
- Do not fill required air space with insulation or other materials.

VENTILATION REQUIREMENTS

Direct connection as a natural draft, grease-rated chimney system per NFPA 96 and UL 2162 is recommended. If the duct run exceeds 20 feet or incorporates a 90° elbow, a UL 705 & UL 762 listed rooftop exhaust fan shall be installed to ensure adequate pressure within the duct. A Listed Type 1 exhaust hood, or one constructed in accordance with

all relevant local and national codes (NFPA 96), may also be installed above the oven in instances where a natural/power draft chimney system is otherwise impossible. See "Ventilation Document - Pavesi" for details.

Operational airflow: 150-200 CFM
Static Pressure at Flue Collar: 0.05 in H₂O

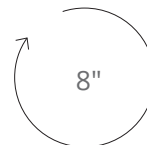

FLUE COLLAR CONNECTION DIAMETER (EXTERNAL)

ELECTRICAL REQUIREMENTS

Wood-Fired

- No Electrical Connection Needed

WARRANTY INFORMATION

10 year limited warranty on internal refractory parts, 1 year limited warranty on electrical, gas and other components. See warranty document for details.

FORZA FORNI
601 N Main St, Brewster, NY 10509
Email: info@forzaforni.com
www.forzaforni.com

844-OVEN-INC (844-683-6462)
Toll-free in USA
(Hablamos Español,
Falamos Português)

Listed to: UL 2162-ULC/ORD C2162,
ANSI Z83.11-CSA 1.8, & NSF-4 for
Commercial Wood Fired and
Gas Fired Cooking Equipment

